

Laboratory Repetitive Dispensing Syringes  
Laboratory Glass Syringes  
Chromatography Vials, Caps, Septas,  
Glass Micro Capillaries

---



# About us

Top Syringe Mfg Co (P) Ltd is a leading manufacturer of glass syringes and glass tube engineering products for decades. The group, established in 1964, has the core technology base of Glass tube engineering making glass syringes from 0.25ml to 100ml and beyond.

The company has 2 manufacturing Plants in India; one is in Dahisar, Mumbai & the other one is at Alandi, Pune. These facilities meet all the regulatory / quality guidelines for products manufactured. Products so manufactured are regularly exported across the globe to over 50 countries including regulatory markets.

Within our world class facility we do manufacture our core product Glass Syringes which are used for various applications like in Laboratory, Medical, Industrial, Veterinary, etc. The facility also has fairly big share in production of Chromatography Consumables under the brand Colpak® like Auto Sampler, Head Space Vials, caps & Septas with our regular on-going production of Branded & OEM job work for Laboratory Glass ware like Test Tubes, Culture Tubes, Glass Micro Capillaries etc. The facility has its own injection molding machines for the screw caps and other plastic products. The Facility is also house to its own rubber mixing mill and processing of the liners & septas.

We have also indigenously developed & established our presence into the manufacturing of the special class of Gas Tight Syringes & Microliter Syringes (Upcoming).

We are in the process of launching our range of Liquid Handling Products like air displacement pipettes, bottle top dispensers, battery operated dispensers, etc.

We are well supported by Our E-commerce team which forms the backbone for our global presence across the world for quality scientific glass products. We have web support for 13+ languages across the world with our E-commerce partners like Amazon, Alibaba, Indiamart, etc. who are helping us distribute our products across the globe.

Our expertise and world class technology developed over the years in Glass tube engineering is the foundation of our quality reputation. Our skill mix with art of glass working, enables us to convert the glass products that command respect from satisfied users worldwide.

This catalog is dedicated to our range of Laboratory Glass Syringes.

Our other group companies manufactures glass pharmaceutical packaging product and laboratory heating and cooling equipments.



**We Supply on OEM term as well**

# INDEX

---

Self-Refilling Syringe	...04
Liquid Dispensing Pipettor	...06
Gas Tight Syringes	...08
Repeater Dispenser	...09
Interchangeable Glass Syringe	...10
Control Glass Syringe	...11
Calibrated Glass Syringe	...12
Reusable Needles	...13
Disposable Glass Capillaries	...14
- TLC Capillary for Spotting	
- Melting Point Microcapillary	
- Graduated Capillary with Colour Code	
- Blood Sampling	
Dispense Glass Syringe	...16
Gas Syringe	...16
Culture Tubes	...17
Test Tubes	...17
Storage Vials	...18
Stirring Rods	...18
U-Tube	...19
9mm Screw Vials	...20
11mm Crimp Vials	...21
11mm Screw Vials	...22
8mm Screw Vials	...23
13mm Screw Vials	...24
Limited Volume Insert	...25
Headspace Vials	...26
Haemometer	...27

## BLISSFILL

### Automatic self-refilling syringe for laboratory repetitive dispensing with Calibration Certificate

- Automatic self-refilling for the repetitive dispensing of liquids in the laboratory
- Liquids / Applications include:
  - Reagent Distribution
  - Hot Agar
  - Sterile Work
  - Filling of well plates
  - HPLC Vial Preparation
  - Small Batch Injection Vials
  - Distribution of Cell Culture Media
  - Perfume Filling
  - CBD oil filling
- Autoclavable at 121°C for 20 minutes
- Dosing Accuracy : Tolerance < 0.4% of dose
- Inert Liquid path:
  - Silicone, Borosilicate Glass, FPM, Stainless Steel
- Fast & Reliable volume selection
- Simple and natural movements
- Fast and reliable volume selection
- Clear visibility of dose
- Calibration certificate with each syringe
- Easy to clean



scan QR code to see the video



### Feed Tube Set

Catalogue No.	Size	Volume	Packing
BFTS-05	0.5 ml	0.05 ml	1pc
BFTS-10	1 ml	0.05 ml	1pc
BFTS-20	2 ml	0.1 ml	1pc
BFTS-50	5 ml	0.25 ml	1pc
BFTS-100	10 ml	1.00 ml	1pc



### Bottle Mounted Set

Catalogue No.	Size	Volume	Packing
BBMS-05	0.5 ml	0.05 ml	1pc
BBMS-10	1 ml	0.05 ml	1pc
BBMS-20	2 ml	0.1 ml	1pc
BBMS-50	5 ml	0.25 ml	1pc

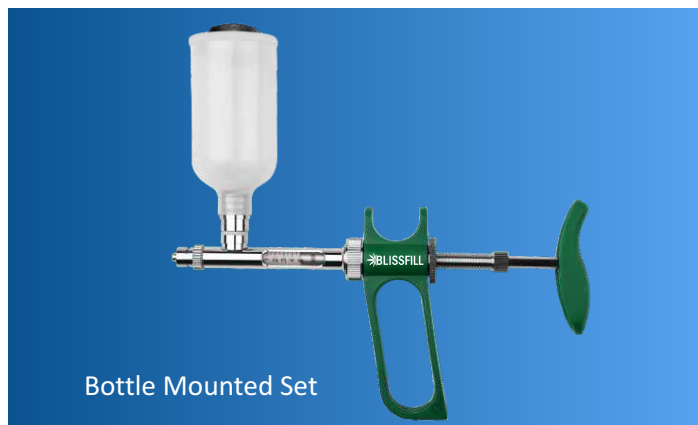

# Liquid Handling

## BLISSFILL Accessories

Item	Catalog	Size	Packing
Glass Barrel, Grounded, Interchangeable	BF-50-GB	0.5ml	Each
	BF-100-GB	1ml	Each
	BF-200-GB	2ml	Each
	BF-500-GB	5ml	Each
	BF-1000-GB	10ml	Each
Spare bag includes Springs, Balls, Washer for Valve & Barrel	BF-50-SK	0.5ml	Each
	BF-100-SK	1ml	Each
	BF-200-SK	2ml	Each
	BF-500-SK	5ml	Each
	BF-1000-SK	10ml	Each
Feed Tubes	BF-1000-FT	0.5-10ml	-1x1mtr
Viscous Spring	BF-50-VS	0.5ml	Each
	BF-100-VS	1ml	Each
	BF-200-VS	2ml	Each
	BF-500-VS	5ml	Each
1) Sinkers	BF-5000-SI	0.5-10ml	Each
2) Intake Valves	BF-5000-IV	0.5-10ml	Each
3) Luer locks	BF-5000-LL	0.5-10ml	Each
1) Short Vent Cannulas	BF-5000-VC	0.5-10ml	Each
2) Long Feed Cannulas	BF-5000-VC	0.5-10ml	Each
Mounted PP Reservoirs	BF-5000-BMS	60ml	Each
Vial Holder Conversion Set with valve	BF-5000-VHC		Each
Rubber Washer	BF-5000-RW	0.5-10ml	10
Feed Tubing conversion set	BF-5000-FTC		Each



## CORTO Liquid Dispensing Pipettors with Calibration Certificate

**Liquid dispensing pipettor with dose by dose dispensing & continuous dispensing options**

- Dose by dose dispensing & Continuous dispensing options
- Fluid transfer without the capital investment required for filling pumps
- Low maintenance
- Sizes 2ml, 5ml, 10ml, 20ml
- Detachable 2 way valve option
- The device is for use with a wide variety of reservoirs including vials, syringes, oral medication containers. Also used for drug dosage distribution and reconstitution in hospital pharmacies
- Applications:
  - Lab repetitive sample preparation
  - Fluid Transfer
  - Hazardous chemicals handling
  - Dose by dose distribution
  - Repetitive dispensing distribution
  - Sterile work
  - Animal Injection
  - Sterile media filling in aseptic conditions
- Calibration certificate with each syringe
- Features:
  - Simple screw adjustment for accurate volume setting
  - Automatic return of spring loaded plunger to preset volume for quick repeat dispensing
  - Filling assembly attachment enables continuous refilling from reservoir and repetitive delivery of preset volumes
  - Unique design of metal bivalve and sinker ensures smooth, leak proof liquid transfer
  - Inert Liquid Path:
    - Silicone, Borosilicate Glass, FPM, Stainless Steel
  - Simple natural movements
  - Plunger tightness without 'O' ring
  - Autoclavable at 121°C for 20 minutes
  - Dosing accuracy: tolerance < 0.4% of dose
  - Clear visibility of dose

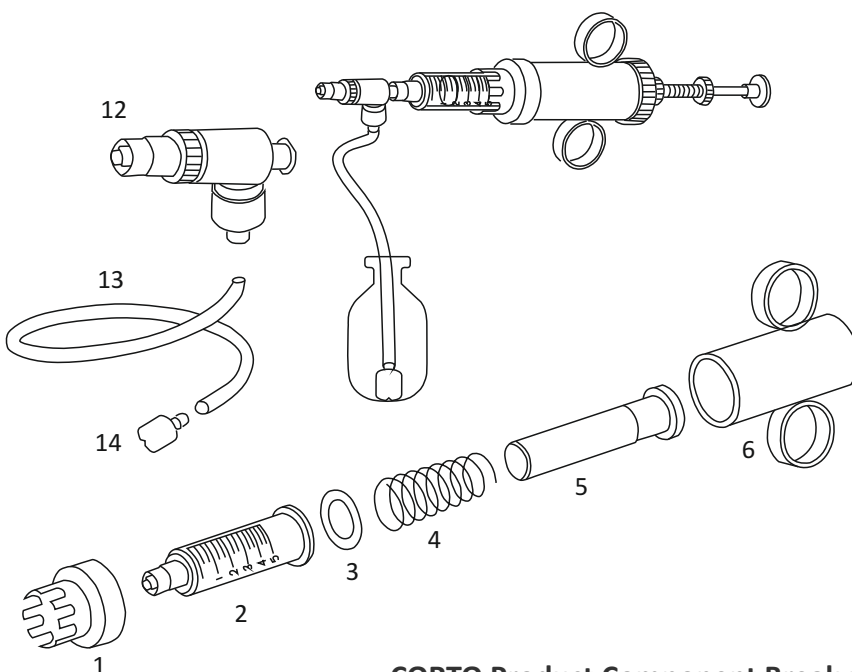
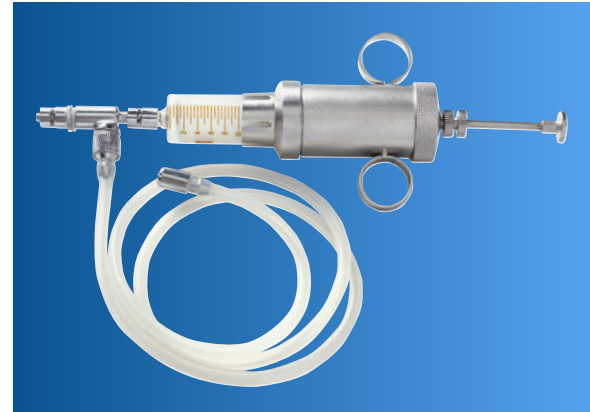
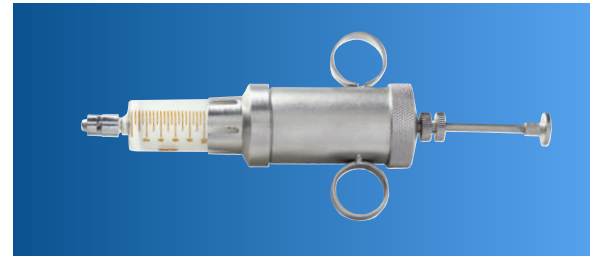



scan QR code to see the video

- |                         |                                 |
|-------------------------|---------------------------------|
| 1. Metal Extension      | 7. S. S. Piston                 |
| 2. Glass Syringe Barrel | 8. Handle Cap                   |
| 3. S. S. Washer         | 9. Locking Nut                  |
| 4. S. S. Spring         | 10. Volume Adjustable Screw Nut |
| 5. Glass Syringe Piston | 11. S. S. Thumb Rest            |
| 6. Metal Holder         | 12. 2 Way Valve                 |
|                         | 13. Tubing                      |
|                         | 14. Sinker                      |

**CORTO Product Component Break up**

# Liquid Handling

## CORTO Accessories

Item	Catalog	Size	Graduation	Pack	
CORTO Syringe Dose by Dose	14-05-00-00	2ml	0.05ml	Each	
	14-08-00-00	5ml	0.2ml	Each	
	14-09-00-00	10ml	0.5ml	Each	
	14-10-00-00	20ml	1ml	Each	
CORTO Syringe Kit Repetitive Dose	14-05-30-00	2ml	0.05ml	Each	
	14-08-30-00	5ml	0.2ml	Each	
	14-09-30-00	10ml	0.5ml	Each	
	14-10-30-00	20ml	1ml	Each	
CORTO Glass Syringe with Metal Luer Lock Tip	14-05-02-03	2ml	0.05ml	10pcs	
	14-08-02-05	5ml	0.2ml	10pcs	
	14-09-02-06	10ml	0.5ml	10pcs	
	14-10-02-07	20ml	1ml	10pcs	
Available in Glass Tip		Metal Tip		SS Luer Lock	
Pipetting Reusable Needles with Blunt Tip	14-25-32-31	2ml	Gauge 20	Length 1.5Inch	
	14-25-32-32	0.5ml	Gauge 16	Length 4Inch	
	14-25-32-33	10-20ml	Gauge 14	Length 4Inch	
CORTO Two Way Valve	14-25-29-00	2,5,10ml		Each	
	14-25-31-00	20ml		Each	
CORTO Spare Kit Set (2 Balls, 2 Springs, 2 Washers for Valve)	14-25-29-45	2,5,10ml		Each	
	14-25-31-45	20ml		Each	
CORTO Silicon Tube (ID 3.2mm OD 6.4mm)	14-25-00-49	1mtr		Each	
CORTO Sinkers	14-25-00-39	2-20ml		Each	

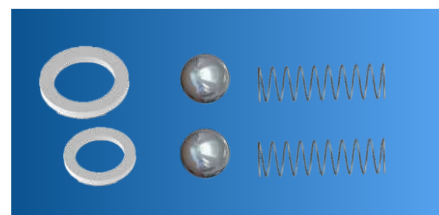
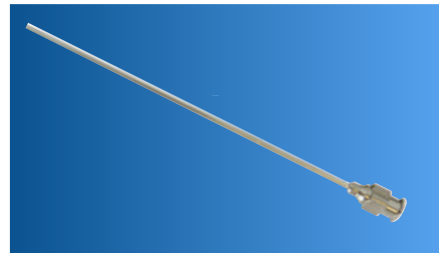
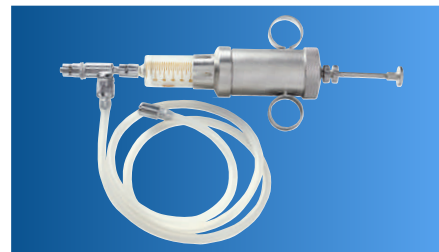

## TRÜTH Gas Tight Syringes

Truth gas tight syringes are ideal for dispensing both liquids and gases. They have a precision-machined PTFE plunger tip which creates a leak-free seal. With the tight fit, the tip essentially wipes the interior of the syringe barrel free of sample. Barrels made of 3.3 expansion glass. All syringes are precision within 1%

Volume		2.5ml	5ml	10ml	25ml
Scale length, mm		60	60	60	60
Total scale divisions		100	100	100	100
Major graduations, mL		0.5	0.5	1.0	2.5
Minor graduations, mL		0.1	0.1	0.2	0.5
Sub-Minor graduations, mL		0.05	0.05	0.1	0.25
Maximum temperature	°C	115	115	115	115
	°F	239	239	239	239
Minimum temperature	°C	10	10	10	10
	°F	50	50	50	50
Maximum Pressure rating	bars	14	14	14	7
	psig	200	200	200	100

Individual Calibration Certificate available on request.

Termination	Volume	Reference	Catalog
Luer Tip	2.5ml	81401	42-24-01-67
	5ml	81501	42-08-01-73
	10ml	81601	42-09-01-74
	25ml		42-30-01-75
PTFE Luer Lock	2.5ml	81420	42-24-65-67
	5ml	81520	42-08-65-73
	10ml	81620	42-09-65-74
	25ml	82520	42-30-65-75
Fixed Needle Beveled	2.5ml	81417	42-24-66-67
	5ml	81517	42-08-66-73
	10ml	81617	42-09-66-74
Fixed Needle Blunt	2.5ml	81416	42-24-68-67
	5ml	81516	42-08-68-73
	10ml	81617	42-09-68-74
XL- Side Hole with ¼" UNF Thread, ZDV, C-KP	10ml	-	80-09-70-74

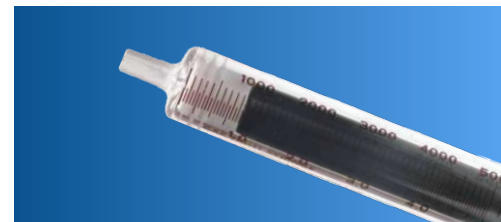



## Inox Liquid Repeater Dispenser

### Repetitive accurate dispensing of 30µl

The *Inox* "T-1000" Repeating Dispenser is a low cost, high accuracy accessory for repetitive dispensing. Each press of the button dispenses 1/50th of the syringe volume. The precision fluid measuring device consistently dispenses samples up to 50 times.

- *Inox* Repeater Dispenser mechanically advances the syringe plunger by 1.2mm
- On a 60mm scale length at full volume of the respective syringe, the 1/50th volume is accurately dispensed
- Autoclavable at 121°C for 20 minutes
- Dosing Accuracy : Tolerance < 1% of dose
- Calibration certificate with each syringe.
- 1.5ml syringe can dispense volumes of 30µL respectively.
- Some typical uses includes:
  - Preparing standard solutions
  - Filling microliter trays
  - Feeding cell cultures
  - Spotting TLC plates
  - Human leukocyte locus-A (HLA) tissue typing
  - Dosing small animals (Intracerebral)
  - Industrial applications include lubricating small bearings or parts, applying liquid solder, and dispensing mercury

It is the most versatile, hand-held, semi-automated dispensers available in the market today. The repeating dispenser is compatible with the fixed needle (LTN), luer tip (LT), or PTFE Luer Lock (TLL) syringes. The size available is of 1.5ml, which can dispense volumes of 30µL respectively with the "T-1000." Every time you press the dispenser button, the "T-1000" Repeating Dispenser mechanically advances the syringe plunger by 1.2mm. Based on a 60 mm scale length at full volume of the respective syringe, the 1/50th volume is accurately dispensed. Most fluids can be effectively handled using either a 22 gauge needle. You can use with the Luer Tip (LT), syringes and to work with your specific needles. The TRUTH "T-1000" dispenser has virtually unlimited applications when there is a need to deliver liquid volumes of 30µL repeatedly up to 50 times before refilling.



Repeater Dispenser with Syringe



TRUTH  
Center All Glass Tip Syringe  
( 42-61-01-80 )



*Inox*  
Repeater Dispenser (T-1000)

Item	Volume	Graduation	Pack	Catalog
TRUTH Center all Glass Tip (CT) Syringe	1.5ml	0.03ml	1pc	42-61-01-80
<i>Inox</i> Repeater Dispenser			1pc	T-1000

## TRÜTH Interchangeable Glass Syringes

Ideal for laboratory liquid handling of various liquids including Plastic Sensitive Materials, hazardous chemicals, Adjuvant solutions, petroleum derivatives, glues, synthetic dyes, perfumes, essential oils and organic chemicals.

- Glass Barrels & Pistons are made from borosilicate glass provide protection against thermal shock
- Graduation marks are permanently fused into a glass barrel
- Standard Luer Lock Syringes confirm to ISO 594/1 ; 595/2
- Precision shrinking ensures improved leak free smooth operation
- Coloured plunger facilitates dosage measurements
- Autoclavable at 121°C
- We supply in private label terms as well
- Luer locks are made of Brass Nickel-Chrome & Stainless Steel (SS316) plated
- Inert liquid path, No 'O' ring



Termination	Volume	Graduation	Packing	Catalogue
Center all	1ml	0.05ml	10pcs	01-03-01-03
Glass Tip	2ml	0.1ml	10pcs	01-05-01-04
(CT)	3ml	0.1ml	10pcs	01-07-01-04
	5ml	0.2ml	10pcs	01-08-01-05
	10ml	0.2ml	10pcs	01-09-01-05
	20ml	0.5ml	10pcs	01-10-01-06
	30ml	1ml	1pc	01-11-01-07
	50ml	2ml	1pc	01-13-01-08
	100ml	2ml	1pc	01-15-01-08

Termination	Volume	Graduation	Packing	Catalogue
Metal	1ml	0.05ml	10pcs	01-03-02-03
Luer	2ml	0.1ml	10pcs	01-05-02-04
Lock Tip	3ml	0.1ml	10pcs	01-07-02-04
(CL)	5ml	0.2ml	10pcs	01-08-02-05
	10ml	0.2ml	10pcs	01-09-02-05
	20ml	0.5ml	10pcs	01-10-02-06
	30ml	1ml	1pc	01-11-02-07
	50ml	2ml	1pc	01-13-02-08
	100ml	2ml	1pc	01-15-02-08

Termination	Volume	Graduation	Packing	Catalogue
Stainless	1ml	0.05ml	10pcs	01-03-75-03
Steel (SS316)	2ml	0.1ml	10pcs	01-05-75-04
Luer Lock Tip	3ml	0.1ml	10pcs	01-07-75-04
(SS-CL)	5ml	0.2ml	10pcs	01-08-75-05
	10ml	0.2ml	10pcs	01-09-75-05
	20ml	0.5ml	10pcs	01-10-75-06
	30ml	1ml	1pc	01-11-75-07
	50ml	2ml	1pc	01-13-75-08
	100ml	2ml	1pc	01-15-75-08

Also available with Metal Tip  on request

# Glass Syringes

## TRÜTH™ Control Glass Syringes / Glass & Metal Syringes

Control glass syringes with 3 finger ring, glass or stainless steel piston & rubber ring. Reusable glass syringe for laboratory liquid handling.

- The 3 ring offers better grip while holding the syringe & administering the dose
- Solid glass / metal version
- Graduated glass syringe with precision cut
- Ground-in piston with 'O' ring made of stainless steel
- Autoclavable (134°C or 273°F)
- Plunger and Glass Syringes can be interchanged as desired
- The SS Piston Glass Syringes is transparent and even after long use shows no sign of wear, as does the stainless steel plunger
- The plunger is smooth and so ensures enhanced tightness
- Applications include:
  - Single hand operation in lab
  - For filtration application with any brand of syringe filter
  - Luer lock attachment to secure needle

Control Glass Syringe comes with Metal Luer Lock Tip (CL), 3 finger ring, Glass or Stainless Steel Piston.



Control glass syringe with 3 finger ring with 'O' ring



Control glass syringe with Stainless Steel Piston

Volume	Graduation	Pack	Glass Piston	Stainless Steel Piston with 'O' ring
2 ml	0.01 ml	1pc	19-05-02-04	---
3 ml	0.01 ml	1pc	19-07-02-04	—
5 ml	0.2 ml	1pc	19-08-02-05	---
10 ml	0.2 ml	1pc	19-09-02-05	19-30-02-05
20 ml	0.5 ml	1pc	19-10-02-06	19-31-02-06
50 ml	2 ml	1pc	19-13-02-08	19-32-02-08

## TRÜTH™ Record Glass Syringes

Record Glass Syringes are available with Metal Record Tip and Metal Luer Lock Tip (CL). Metal Pistons with 'O' ring.

Capacity	Packing	Metal Record Tip	Metal Luer Lock Tip
1 ml	1pc	17-04-21-02	17-04-02-02
2 ml	1pc	17-05-21-05	17-05-02-05
5 ml	1pc	17-08-21-06	17-08-02-06
10 ml	1pc	17-09-21-07	17-09-02-07
20 ml	1pc	17-10-21-08	17-10-02-08
50 ml	1pc	17-13-21-10	17-10-02-08

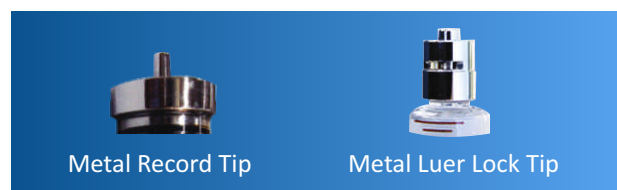

Metal Record Tip

Metal Luer Lock Tip



Record glass syringe with metal record tip

# Glass Syringes

## TRÜTH™ Calibrated Glass Syringes with Calibration certificate (as per ISO 4788)

### PLS Glass Syringes (Pressure Laboratory Syringes)

TRÜTH Calibrated Glass Syringes (PLS) are Certified Volumetric measuring Instruments as per Class A ISO 4788. The syringes offer a jerk free experience while collecting and dispensing accurate liquid doses through a 100% inert liquid path of borosilicate glass that also withstands higher pressures. Recommended for your Good Laboratory Practices (GLP) / GMP Certified facility at quality control, quality assurance etc.,

- Class of accuracy is Class A as per ISO 4788
- Permissible error of + 1% & 0.5%
- Autoclavable at 121°C
- Outstanding Chemical Resistance being made of 'Glass'
- Extremely air tightness and can hold a particular pressure.
- 100% jerk free movement
- Fine graduation markings (up to 0.01ml)
- Luer locks are Nickel-chrome plated brass & Stainless Steel (SS316)



Termination	Volume	Graduation	Packing	Catalogue
Center all	0.25 ml	0.01 ml	10pcs	04-01-01-01
Glass Tip	0.5 ml	0.01 ml	10pcs	04-02-01-01
(CT)	1 ml	0.01 ml	10pcs	04-04-01-01
	2 ml	0.05 ml	10pcs	03-06-01-03
	5 ml	0.1 ml	10pcs	03-08-01-04
	10 ml	0.1 ml	10pcs	03-09-01-04
	20 ml	0.5 ml	10pcs	03-10-01-06
	50 ml	0.5 ml	1 pc	03-13-01-06
	100 ml	0.5 ml	1 pc	03-15-01-06

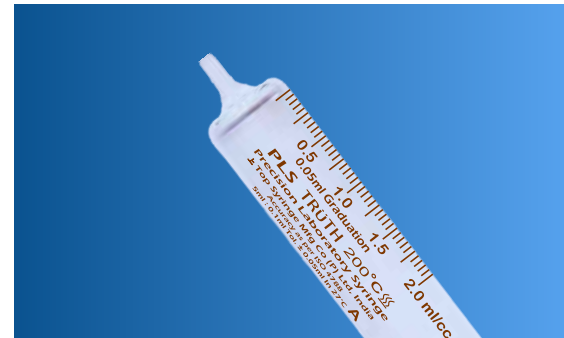

Termination	Volume	Graduation	Packing	Catalogue
Metal	1 ml	0.01 ml	10pcs	04-04-02-01
Luer	2 ml	0.05 ml	10pcs	03-06-02-03
Lock Tip	5 ml	0.1 ml	10pcs	03-08-02-04
(CL)	10 ml	0.1 ml	10pcs	03-09-02-04
	20 ml	0.5 ml	1pc	03-10-02-06
	50 ml	0.5 ml	1pc	03-13-02-06
	100 ml	0.5 ml	1pc	03-15-02-06

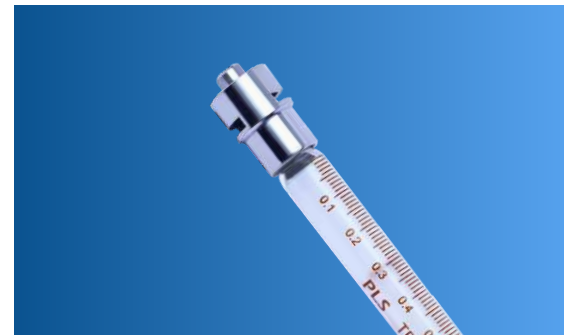

Termination	Volume	Graduation	Packing	Catalogue
Stainless	1 ml	0.01 ml	10pcs	04-04-75-01
Steel (SS 316)	2 ml	0.05 ml	10pcs	03-06-75-03
Luer Lock Tip	5 ml	0.1 ml	10pcs	03-08-75-04
(SS-CL)	10 ml	0.1 ml	10pcs	03-09-75-04
	20 ml	0.5 ml	1pc	03-10-75-06
	50 ml	0.5 ml	1pc	03-13-75-06
	100 ml	0.5 ml	1pc	03-15-75-06

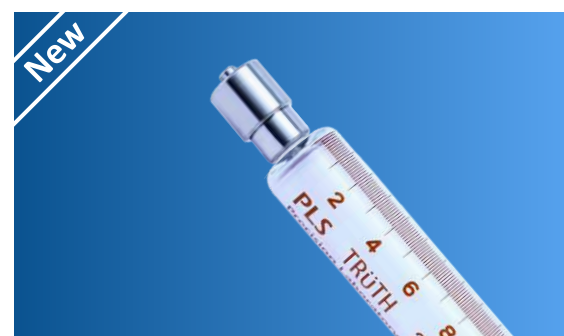

Also available with Metal Tip  on request

# Glass Syringes

## TRÜTH™ Reusable Needles

We offer a variety of needles for laboratory use. All needles are made with type 304 stainless steel cannulae. They are good ground and electro polished on high precision machines. Needles are fitted with standard nickel plated luer hubs.

Catalog	Size	Catalog	Size
TN-0414B	14 G x 4"	TN-1218B	18 G x 12"
TN-0316B	16 G x 3"	TN-0319B	19 G x 3"
TN-0616B	16 G x 6"	TN-0419B	19 G x 4"
TN-0816B	16 G x 8"	TN-0619B	19 G x 6"
TN-1216B	16 G x 12"	TN-0819B	19 G x 8"
TN-0417B	17 G x 4"	TN-1019B	19 G x 10"
TN-0617B	17 G x 6"	TN-1219B	19 G x 12"
TN-0817B	17 G x 8"	TN-0822B	22 G x 8"
TN-1017B	17 G x 10"	TN-1022B	22 G x 10"
TN-1217B	17 G x 12"	TN-0223B	23 G x 2"
TN-0318B	18 G x 3"	TN-0423B	23 G x 3"
TN-0418B	18 G x 4"	TN-0623B	23 G x 6"
TN-0618B	18 G x 6"	TN-0823B	23 G x 8"
TN-0818B	18 G x 8"	TN-1023B	23 G x 10"
TN-1018B	18 G x 10"	TN-1223B	23 G x 12"

## TRÜTH™ Pipetting Reusable Needle with Bevels

Catalog	Size
14-25-32-31	2ml / 20G x 1½"
14-25-32-32	0.5ml / 16G x 4"
14-25-32-33	10-20ml / 14G x 4"
65-35-48-36	50ml / 15G x 5"

### Special Needles Available on Request

A variety including standard hypodermic needle, veterinary needles, laboratory needles, blunt needles, animal research also available on request. Requirements with specific gauges, lengths and types available on request including Stainless Steel hubs used during special applications and working with corrosive materials or critical procedures. Kindly enquire with us today for your special needles and we shall be glad to cater them to you. Your requests for OEM are also welcomed. Please mail us on [sales@topsyringe.com](mailto:sales@topsyringe.com)

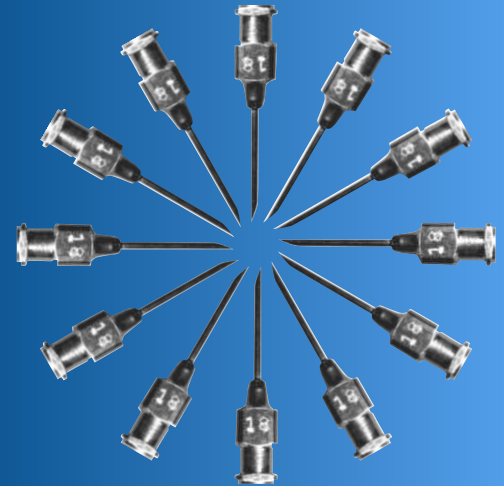

Beveled Needles



Blunt Needles

# Laboratory Glassware



## Disposable Glass Capillaries. Made of Superior 3.3 exp Borosilicate Glass

### TLC Disposable Glass Capillary for Spotting

Non calibrated tubes made from borosilicate glass for use with aqueous and organic solutions. Useful for depositing small amounts of sample onto a TLC (thin layer chromatography) plate. This prevents overloading and help achieve an accurate and clear tlc in preparation for running a small column.

Catalog No.	Length	I.D. ( $\pm 0.10$ mm)	No. of Caps /weight Per Vial
21-00-011	4 Inch Capillary	0.55	100 caps
21-00-012	4 Inch Capillary	0.55	250 caps
21-00-015	5 Inch Capillary	0.55	100 gm
21-00-016	8 Inch Capillary	0.55	200 gm
21-00-017	10 Inch Capillary	0.55	200 gm
Refill pack			
21-00-911	4 Inch Capillary	0.55	100 caps
21-00-912	4 Inch Capillary	0.55	250 caps

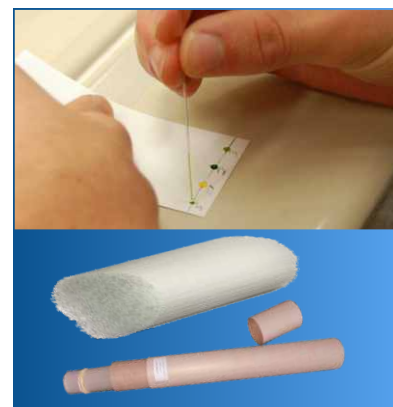

## Melting Point Microcapillary

Mucaps are high precision capillary pipettes made of borosilicate neutral glass with a precision bore, accurately cut and free polished.

Catalog No.	Description	Length (mm)	I.D. ( $\pm 0.10$ mm)	No. of Caps Per Vial
20-00-019	One End Sealed	75	1.00	100
20-00-021	One End Sealed	75	1.00	250
20-00-030	One End Sealed	75	2.00	100
20-00-023	One End Sealed	100	1.00	100
20-00-025	One End Sealed	100	1.00	250
20-00-032	One End Sealed	100	2.00	100
20-00-020	Both Ends Open	75	1.00	100
20-00-022	Both Ends Open	75	1.00	250
20-00-029	Both Ends Open	75	2.00	100
20-00-024	Both Ends Open	100	1.00	100
20-00-026	Both Ends Open	100	1.00	250
20-00-031	Both Ends Open	100	2.00	100
Refill pack				
20-00-919	One End Sealed	75	1.00	100
20-00-930	One End Sealed	75	2.00	50
20-00-923	One End Sealed	100	1.00	100
20-00-932	One End Sealed	100	2.00	50
20-00-920	Both Ends Open	75	1.00	100
20-00-929	Both Ends Open	75	2.00	50
20-00-924	Both Ends Open	100	1.00	100
20-00-931	Both Ends Open	100	2.00	50



# Laboratory Glassware



## Graduated Capillary with colour code

Gr capillary pipettes are calibrated to contain specified volume when filled  
Between end opposite to colour code band (indicating capacity) and black ring  
(including graduation)

Catalogue	Size (µl)	No. of marks & position	I.D. (±0.10mm)	Tol.	Caps per Vial	Colour Code
22-02-005	5	5 marks at 1,2,3,4,5µl	0.32	±2%	250	White
22-12-005	5	1 mark at 5µl	0.32	±1%	250	Orange
22-02-010	10	2 marks at 5, 10µl	0.45	±1%	250	Orange
22-12-010	10	1 mark at 10µl	0.45	±1%	250	2 x White
22-02-020	20	1 mark at 20µl	0.64	±1%	250	Green & Black
22-02-025	25	1 mark at 25µl	0.64	±1%	250	Green & Red
22-02-050	50	1 mark at 50µl	1.00	±1%	250	Green
22-02-100	100	1 mark at 100µl	1.25	±1%	250	Green
22-02-200	200	1 mark at 200µl	1.80	±1%	250	Red



## Blood Sampling

Catalogue	Description	Length mm	Caps Per Vial
20-00-011	Haematocrit Capillary, Heparinised	75	100
20-00-012	Haematocrit Capillary, Non Heparinised	75	100
20-00-017	BTCT (Bleeding Time Clothing Time)	90	100
20-00-018	BTCT (Bleeding Time Clothing Time)	90	250
22-02-027	Mice Bleeding Capillary	32	100
22-02-028	Rat Bleeding Capillary	52	100
20-00-015	Heparinised Blood Gas Analyzer	125	100
20-00-016	Non-Heparinised Blood Gas Analyzer	125	100
20-00-014	Strumia Non-Herpernised capillary	32	100
20-00-013	Strumia Herpernised Capillary	32	100
	Refill pack		
20-00-917	BTCT (Bleeding Time Clothing Time)	90	100



# Glass Syringes

## TRÜTH™ DISPENSE GLASS SYRINGES

**100% inert liquid path instrument for aliquot collection from dissolution test apparatus**

- The bent glass tube on the Borosilicate Glass syringe allows easy collection of the liquid sample solution from the Dissolution vessels.
- The inert borosilicate liquid path ensures that there are no contaminations, particle diffusions, absorptions or reactions from the sampling cannulae or Autosampler of Dissolution test apparatus.
- Plastic syringes / tubes, Stainless Steel needles tend to have qualities of absorption which also might react with the sensitive solutions.
- These accurate and precise results are the helpful and base for Multimedia Dissolution for bio-equivalence study ahead in the new product development & have to match with reference listed drugs products (RLDs) for the US, EU and other markets
- USP <711> recommends the use of glass and inert materials for the apparatus used in the procedure, and for sampling. Drugs which specifically need to be handled by glass include hormonal products as well as non-hormonal products e.g. Levothyroxine sodium tablets etc
- Using the Truth syringe eliminates the fear of doubt with respect to contamination during the critical tablet dissolution study.

Termination	Volume	Graduation	Pack	Catalog
Bend Tip	10ml	0.01ml	1pc	01-09-77-05
Nozzle	20ml	0.01ml	1pc	01-10-77-06



## TRÜTH™ GAS SYRINGES

**Gas syringes, truth, 100ml with 40mm capillary tube, borosilicate glass, amber graduation printed of 1ml. Supplied without glass stopcock.**

- All gases can be collected using a gas syringe used to collect and measure volumes of gases during reactions producing gases.
- The gas syringe is connected by a tube to the flask that is giving off the gas as shown in the images.
- The gas syringe has marks along its length that allow the volume of collected gas to be measured.
- As the volume of collected gas increases, the plunger moves further out of the syringe.
- The volume of collected gas can be measured in time as it increases, a graph of volume against time can be plotted.
- This can be used to show the rate of the reaction.

Termination	Volume	Graduation	Pack	Catalog
Capillary Nozzle	100ml	1ml	1pc	27-15-24-13





## Hyalus Disposable Culture Tubes

Hyalus premium quality glass tubes are produced from borosilicate glass that provides excellent chemical resistance and durability. The tubes are available in various sizes and feature uniform bottoms and fire polished rims. They are neatly packaged in boxes of 250 and are shrink-wrapped in plastic film to keep them particle free.

- Made from superior quality borosilicate glass to reduce pH changes and contaminants that are potentially leached from tubes made from soda lime glass
- Tubes can be used for tissue culture and blood banks
- Tubes are chemically inert
- Tubes feature well-rounded bottoms and smooth, fire-polished rims
- Dimensional specifications are rigidly controlled for reliable, uniform results
- Suitable for general testing and culturing applications in blood banks, hematology, bacteriology, virology, and tissue culture laboratories

Catalog	Description	Size	Pack
H- 10075	10 X 75mm	3ml	250 Per Box
H- 12075	12 X 75mm	5ml	250 Per Box



## Hyalus Test Tube 3.3

Hyalus Brand glass test tubes are grade I, made from borosilicate hard glass, 33 expansion, with rim, without rim, with uniform thickness for better heat transfer & chemical resistance. Also available under OEM.

Size	With Rim	Without Rim	Pack
10 X 75	6110075	6210075	100pcs
12 X 75	6112075	6212075	100pcs
15 X 100	6112100	6212100	100pcs
15 X 125	6115125	6215125	100pcs
15 X 150	6115150	6215150	100pcs
18 X 150	6118150	6218150	100pcs
25 X 100	6125100	6225100	100pcs
25 X 150	6125150	6225150	100pcs



## Hyalus Culture Tubes

Hyalus brand culture tubes are made from machine drawn, uniform thickness, low expansion borosilicate glass tubing. The bottoms of these are with uniform thickness to withstand both mechanical and thermal shocks. The rims wherever provided, are strong. Culture tubes without rim have heavy fire-polished ends which are resistant to mechanical shocks of daily use. The caps and washers provided on screw cap culture tubes withstand repeated autoclaving.

### Round Bottom Culture Tube with Screw Cap & Rubber Liner

Capacity	Catalog	Description	Packaging
5ml	SP-500-A	16mm x 75mm	100pcs
10ml	SP-500-B	16mm x 125mm	100pcs
30ml	SP-500-C	25mm x 100mm	50pcs
60ml	SP-500-D	25mm x 200mm	50pcs
150ml	SP-500-E	38mm x 200mm	50pcs

### Flat Bottom Culture Tube with Screw Cap & Rubber Liner

Capacity	Catalog	Description	Packaging
5ml	SP-510-A	16mm x 50mm	121pcs
10ml	SP-510-B	25mm x 57mm	50pcs
30ml	SP-500-C	25mm x 95mm	64pcs

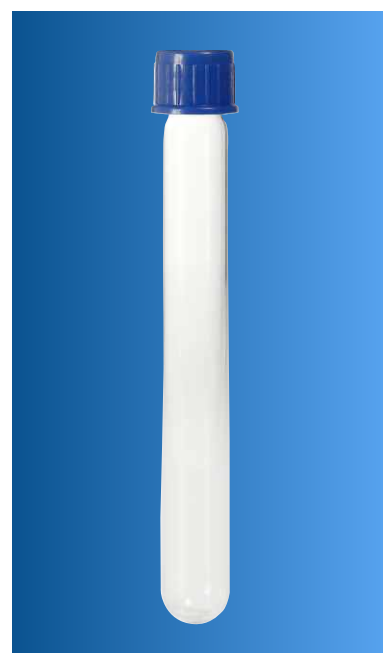

## Colpak® Storage Vials

Screw neck vials for storage purpose made out of 1st hydrol class glass. Vials with different volumes are available. Clear amber glass vials. Seal with different septa materials.

Catalog	Description	Pack
TC80A	2ml Screw Neck Clear Vial, 11.6 x 32mm, 1st hydrol. class	100
TC80C	2ml Screw Neck Amber Vial, 11.6 x 32mm, 1st hydrol. class	100
TC804A	PP Screw Cap, Black, Closed top, Silicone white/PTFE Red, 45° shore A, 1.5mm	100
TC130A	4ml Screw Neck Clear Vial, 14.7 x 45mm, 1st hydrol. class	100
TC130C	4ml Screw Neck Amber Vial, 14.7 x 45mm, 1st hydrol. class	100
TC1304K	PP Screw Cap, Black, Closed top, Silicone white/PTFE Red, 45° shore A	100
TC2420A	20ml Screw Neck Clear Vial, 27.5 x 57mm, 1st hydrol. class	100
TC2420C	20ml Screw Neck Amber Vial, 27.5 x 57mm, 1st hydrol. class	100
TC2430A	30ml Screw Neck Clear Vial, 27.5 x 72.5mm, 1st hydrol. class	100
TC2430C	30ml Screw Neck Amber Vial, 27.5 x 72.5mm, 1st hydrol. class	100
TC2440A	40ml Screw Neck Clear Vial, 27.5 x 95mm, 1st hydrol. class	100
TC2440C	40ml Screw Neck Amber Vial, 27.5 x 95mm, 1st hydrol. class	100
TC2460A*	60ml Screw Neck Clear Vial, 27.5 x 140mm, 1st hydrol. class	100
TC2460C*	60ml Screw Neck Amber Vial, 27.5 x 140mm, 1st hydrol. class	100
TC2404L	PP Screw Cap, Black, Closed top, Silicone white/PTFE Grey, 45° shore A, 1mm	100
TC2405A	PP Screw Cap, Black, Closed top, Silicone white/PTFE Grey, 45° shore A, 3mm	100

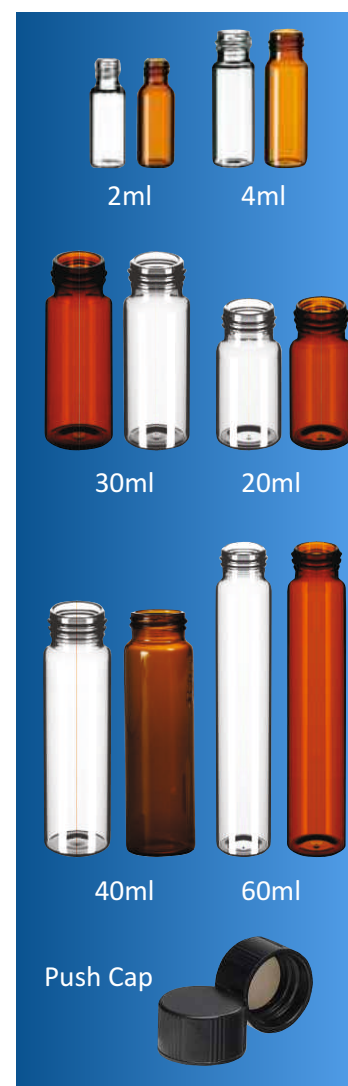

## Hyalus Glass Stirring Rod

Made from exp glass with rounded ends for extra safety and to minimise scratching

Catalog	Thickness	Length
SP-60-A	3mm	100mm
SP-60-B	3mm	200mm
SP-61-B	4mm	200mm
SP-63-B	6mm	200mm

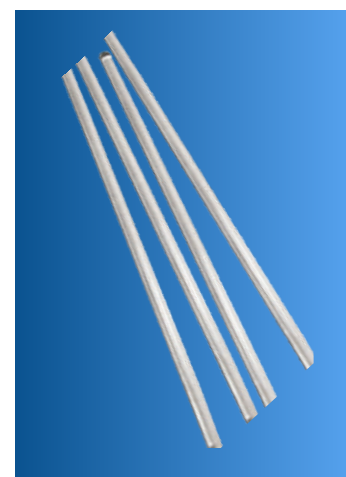

## Colpak® Micro Storage Vials (High Recovery) for Custom Synthesis & Pharmaceuticals Impurities (U-Tube)

When small volume samples have to be dispatched, it is often difficult to either retrieve the micro volume sample from the vial or to apply a label holding all the necessary information on the limited space available. The solution is our short-insert storage vial. The insert is fused with the outer body so that even powder can be retrieved easily.

The wide opening and the low depth of the insert, allow the use of a pipette. The long vial body allows the application of a reasonably sized label and the handling of the vial with gloves. Thanks to the conical insert, smallest volumes may be retrieved.

### MATERIALS

Vial : Borosilicate Glass, Type 1

Screw Cap : Polypropylene

Septa/ Liner : liner, Silicon with PTFE coating

### APPLICATIONS

- Custom Synthesis
- Impurities
- Pharmaceutical Packaging

### 0.5ml Micro Storage U-Tube Vials

Description	Height	White Cap With Liner	White Cap With Leak Proof Plug Cap
Clear Open Bottom	52mm	TC 1600 A	TC 1600 APC
Amber Open Bottom	52mm	TC 1600 C	TC 1600 CPC
Clear Closed Bottom	40mm	TC 1640 A	TC 1640 APC
Amber Closed Bottom	40mm	TC 1640 C	TC 1640 CPC



## Colpak® ND 9 Short Screw Thread Vials 12 x 32mm

Why Select 9mm Short Screw Thread Vials?

9mm screw thread vials have a 9-425 GPI thread and the closure is dimensionally equivalent to 11mm crimp cap vials. This means that they can be used in any autosampler that uses 11mm crimp cap vials.

9mm screw caps have an advantage over 11mm crimp caps because 9mm screw caps can easily be applied and removed by hand and they can be reused. All vials are manufactured with USP type 1 glass.

### Colpak® 9mm Short Screw Thread Vials, Wide Opening

Catalog	Description	Pack
TC-90 A	12 x 32mm, Clear Glass, 1st Hydrol Class, Wide Opening	100
TC-90 B	12 x 32mm, Clear Glass, 1st Hydrol Class, Wide Opening, Label + Filling Lines	100
TC-90 C	12 x 32mm, Amber Glass, 1st Hydrol Class, Wide Opening	100
TC-90 D	12 x 32mm, Amber Glass, 1st Hydrol Class, Wide Opening, Label + Filling Lines	100
TC-91ERB	12 x 32mm, PP 9mm Micro-Vial, Transparent	100



TC-90 A

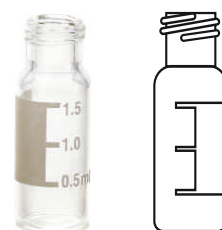

TC-90 B

### Colpak® 9mm Short Screw Thread Septas & Caps

Catalog	Description	Pack
TC-94 BA	PP Blue Knurled Short Screw Thread Cap, 6mm Center Hole Silicone White / PTFE Red	100
TC-94 BB	PP Blue Short Screw Thread Cap, 6mm Center Hole PTFE Red / Silicone White / PTFE Red	100
TC-94 BG	PP Blue Knurled Short Screw Thread Cap, 6mm Center Hole Silicone White / PTFE Red with Pre-Slit	100
TC-94 BD	PP Blue Knurled Short Screw Thread Cap, 6mm Center Hole Silicone White / PTFE Light Blue	100
TC-94 EG	PP Blue Knurled Short Screw Thread Cap, 6mm Center Hole Silicone White / PTFE Light Blue with Pre-Slit	100



TC-90 D



TC - 91 ERB

### Colpak® 9mm PP Blue Knurled Short Screw Thread Cap Bonded Septas

Catalog	Description	Pack
TC-94 BOA	PP Blue Knurled Short Screw Thread Cap, 6mm Center Hole with Bonded Silicone White / PTFE Red	100
TC-94 BOG	PP Blue Knurled Short Screw Thread Cap, 6mm Center Hole with Bonded Silicone White / PTFE Red Pre-Slit	100
TC-94 BIA	PP Blue Knurled Short Screw Thread Cap, 6mm Center Hole with Bonded Silicone Red / PTFE Red	100
TC-94 BIG	PP Blue Knurled Short Screw Thread Cap, 6mm Center Hole with Bonded Silicone Red / PTFE Red Pre-Slit	100

9mm Short Screw Thread Cap & Bonded Septas

Colpak® 9mm Pre-assembled Vials with Caps & Septa available on request as per our combination.



9mm Short Screw Threads Septas & Caps

## Colpak® ND 11 Crimp Neck Vials 12 x 32mm

Why select 11mm Crimp Neck Vials?

Crimp caps provide the tightest seal, reducing the chance of sample evaporation. The 12 x 32mm crimp vials and 11mm aluminium crimp caps are economical and easy to use with crimping tools. All vials are manufactured with USP type 1 glass.

### Colpak® 11mm Crimp Neck Vials

Catalog	Description	Pack
TC-110 A	12 x 32mm, Clear Glass, 1st Hydrol Class, Wide Opening	100
TC-110 B	12 x 32mm, Clear Glass, 1st Hydrol Class, Wide Opening, Label + Filling Lines	100
TC-110 C	12 x 32mm, Amber Glass, Wide Opening	100
TC-110 D	12 x 32mm, Amber Glass, 1st Hydrol Class, Wide Opening, Label + Filling Lines	100



TC-110 A

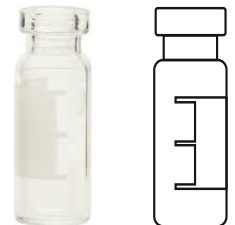

TC-110 B



TC-110 D

### Colpak® 11mm Aluminium Septas & Caps

Catalog	Description	Pack
TC-117	Aluminium Cap 5.5mm Center Hole	100
TC-117 A	Aluminium Cap Clear 5.5mm Center Hole Silicone White / PTFE Red	100
TC-117 B	Aluminium Cap Clear 5.5mm Center Hole PTFE Red / Silicone White / PTFE Red	100
TC-117 G	Aluminium Cap Clear 5.5mm Center Hole Pre-Slit Silicone White / PTFE Red	100



11mm  
Aluminum Cap

### Colpak® 11mm Crimper

- Easy and Convenient handling
- Chemically resistant surface finish especially designed for the application in labs
- Hardened crimping jaws made of a special alloy that guarantees long life

Catalog	Description	Pack
TC-119A	Crimper for 11mm Aluminium Caps	1



## Colpak® ND 11 Snap Ring Vials 12 x 32mm

Why select 11mm Snap Ring Vials?

11mm snap caps provide a secure seal that minimises evaporation, even with volatile samples. Snap caps are often more convenient than crimp caps as they can easily be applied and removed by hand. An audible click ensures a secure seal has been formed and that the cap is correctly aligned. Snap/crimp vials can be closed with either snap caps or crimp caps. All vials are manufactured with USP type 1 glass.

### Colpak® 11mm Snap Ring Vials

Catalog	Description	Pack
TC-110 SA	12 x 32mm, Clear Glass, 1st Hydrol Class, Wide Opening	100
TC-110 SB	12 x 32mm, Clear Glass, 1st Hydrol Class, Wide Opening, Label + Filling Lines	100
TC-110 SC	12 x 32mm, Amber Glass, Wide Opening	100
TC-110 SD	12 x 32mm, Amber Glass, 1st Hydrol Class, Wide Opening, Label + Filling Lines	100



TC-110 SA

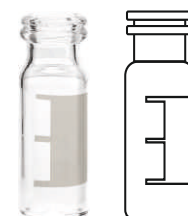

TC-110 SB



TC-110 SD

### Colpak® 11mm Snap Ring Seals

Catalog	Description	Pack
TC-112 SA	PP Clear 6mm Snap Ring Cap, Silicone White/ PTFE Red	100
TC-112 SG	PP Clear 6mm Snap Ring Cap, Pre-Slit Silicone White / PTFE Red	100
TC-112 SI	PP Clear 6mm Snap Ring Closed Cap with Star Membrane	100



11mm Snap Ring Septas & Caps

### Colpak® Micro Inserts

Catalog	Description	Pack
TC-60 A	0.2ml Micro-Insert, 31 x 6mm, Clear Glass, 1st Hydrol Class, Flat Bottom, Fill Vol. 0.35	100
TC-60 B	0.1ml Micro-Insert, 31 x 6mm, Clear Glass, 1st Hydrol Class, Conical, 12mm Top, Fill Vol. 0.30	100
TC-60 C	0.1ml Micro-Insert, 31 x 6mm, Clear Glass, 1st Hydrol Class, Conical, 12mm Top, Fill Vol. 0.25	100
TC-60 D	0.1ml Micro-Insert, 29 x 5.7mm, Clear Glass, 1st Hydrol Class, Mandrel Point with assembled Plastic Spring, Fill Vol. 0.20	100

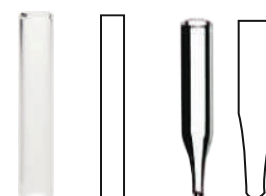

TC 60 A

TC 60 B

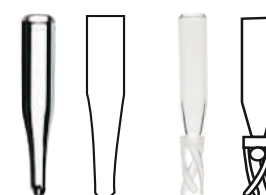

TC 60 C

TC 60 D

## Colpak® HPLC / Autosampler Vials ND 8 Screw Neck Vials 12 x 32mm

Why select 8mm Screw Neck Vials?

8mm (8-4250 screw neck vials are the original smaller opening autosampler vials manufacture with USP type 1 glass. They are designed to work in a variety of autosamplers requiring narrow neck vials.

### Colpak® 8mm Screw Neck Vials

Catalog	Description	Pack
TC-80 A	12 x 32mm, 1st Hydrol Class Clear Glass, Small Opening	100
TC-80 B	12 x 32mm, 1st Hydrol Class Clear Glass, Small Opening, Label + Filling Lines	100
TC-80 C	12 x 32mm, Amber Glass, Small Opening	100
TC-80 D	12 x 32mm, Amber Glass, Small Opening, Label + Filling Lines	100



TC-80 A

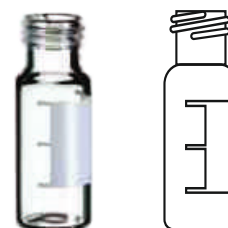

TC-80 B



TC-80 D

### Colpak® PP 8mm Screw Seals

Catalog	Description	Pack
TC-84 KA	PP 8mm Black Knurled Screw Cap, 5.5mm Center Hole Silicone White / PTFE Red, Thickness 1.5mm, Temperature Resistant -60°C to 200°C	100
TC-84 KD	PP 8mm Black Knurled Screw Cap, 5.5mm Center Hole Silicone White / PTFE Light Blue, Thickness 1.5mm, Temperature Resistant -60°C to 200°C	100



8mm Screw  
Septas & Caps

### Colpak® Vials Rack

Catalog	Description	Pack
TC-70	PP Vial Rack 182 x 92 x 16mm, 50 cavities with 12mm diameter	1

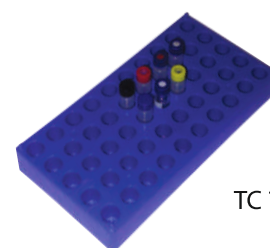

TC 70

# Laboratory Glassware

## Colpak® ND 13 Screw Neck Vials 15 x 45mm

Why select 13mm Screw Neck Vials?

13mm vials have a 13-425 GPI thread and can hold up to 4ml of sample. They are used by the Waters 48-position autosampler and many others. All vials are manufacture with USP type 1 glass.

### Colpak® 13mm Screw Neck Vials

Catalog	Description	Pack
TC-130 A	4ml Clear Glass, 15 x 45mm, 1st Hydrol Class	100
TC-130 B	4ml Clear Glass, 15 x 45mm, 1st Hydrol Class, Label + Filling Lines	100
TC-130 C	4ml Amber Glass 15 x 45mm, 1st Hydrol Class	100
TC-130 D	4ml Amber Glass 15 x 45mm, 1st Hydrol Class, Label + Filling Lines	100



TC-130 A



TC-130 B



TC-130 D

### Colpak® 13mm Screw Seals

Catalog	Description	Pack
TC-136 K	PP Black Screw Cap 8.5mm Center Hole, Silicone White / PTFE Red, 1.5mm Thickness, Temperature Resistant -60°C to 200°C	100

## Colpak® Shell Vials

Why select 13mm Screw Neck Vials?

Shell vials feature thicker walls for safer sample handling. They are compatible with Waters WISPTM 48 and 96 style autosamplers. All shell vials are supplied with polyethylene plug closures - their tear-away design ensures excellent penetration and ventilation during sampling.

Catalog	Description	Pack
TC-712	1ml Shell Vials, Clear Glass, 8.2mm x 40mm, 1st Hydrol Class, 8mm PE-Plug, Soft without insertion barrier for Micro-Insert	100
TC-712 A	1ml Shell Vial, 8.2mm x 40mm, Clear Glass, 1st Hydrol Class	100
TC-712 B	8mm PE-Plug, Transparent (Without Insertion Barrier)	100
TC-712 C	0.8ml Shell Vial Clear Glass, 8.2 x 30mm, (Without PE Plug)	100
TC-712 D	1ml Shell Vial, Amber, 8.2 x 40mm, Clear Glass, 1st Hydrol Class	100
TC-712 DB	1ml Shell Vials, Amber Glass, 8.2 x 40mm, 1st Hydrol Class, 8mm PE-Plug, Soft without insertion barrier for Micro-Insert	100



TC - 712

TC - 712DB



8mm PE-Plug

Fire-polished Neck

Also suitable for\*

**Waters**

\*waters is a Trademark of Waters India Pvt. Ltd.



## Colpak® Limited Volume Inserts

Why select Limited Volume Inserts?

Limited volume inserts are an economical solution in sample analysis to reduce the use and waste of solvents and small samples. For optimum instrument performance and accurate test results, use the guides below to ensure that the correct insert is used with the appropriate autosampler vial.

The insert is neckless and always has to be used within a vial. The diameter of the insert depends on the size of the vial opening. Inserts reduces the volume, so that the needle is capable of picking up even smallest sample quantities. The larger the top of an insert, the more the volume can be reduce.

### Insert Selection Guide

Solvent Compatibility	Glass is most commonly used for vial inserts. Polypropylene may be necessary when using pH sensitive samples.
Targeted Dead Volume	Mandrel point inserts provide the smallest dead volume so are suitable when minimising sample loss is important. Conical bottom inserts provide sufficient sample extraction for most applications.
Price	Flat bottom inserts are the cheapest and may be a viable option for limited sampling. Mandrel point vial inserts are the most expensive but they minimise sample loss and provide excellent injection accuracy.

### Bottom Type

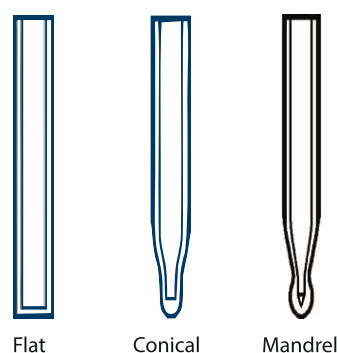

### 0.5ml Micro Storage U-Tube Vials

Catalog	Height	Pack	9mm Screw	11mm Crimp	11mm Snap
TC-60 A	0.2ml Micro-Insert, 6 x 31mm, Clear Glass, 1st Hydrol Class, Flat Bottom, Fill Vol. 0.35ml	100	✓	✓	✓
TC-60 B	0.1ml Micro-Insert, 6 x 31mm, Clear Glass, 1st Hydrol Class, Conical, 12mm Top, Fill Vol. 0.30ml	100	✓	✓	✓
TC-60 C	0.1ml Micro-Insert, 6 x 31mm, Clear Glass, 1st Hydrol Class, Conical, 15mm Top, Fill Vol. 0.25ml	100	✓	✓	✓
TC-60 D	0.1ml Micro-Insert, 5.7 x 29mm, Clear Glass, 1st Hydrol Class, Mandrel Point with assembled Plastic Spring, Fill Vol. 0.20ml	100	✓	✓	✓

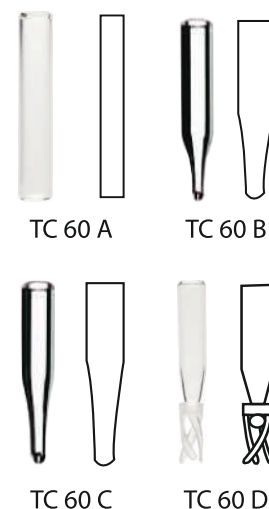

## Colpak® Headspace Vials

Why select Headspace Vials?

Colpak high quality headspace vials have a bevelled neck for a secure seal, uniform glass thickness for even heat distribution and a stable, strong design for even heat distribution and a stable, strong design for ease of use.

They are available with rounded or flat bottom profiles for accurate instrument compatibility. Use with the 20mm headspace caps, septas and seals. All vials are manufactured with USP type 1 glass.

### Colpak® 20mm Headspace Vials

Catalog	Description	Pack
TC-200	10ml Crimp Headspace Clear Vial, 22.5 x 46mm, Flat Bottom	100
TC-200 A	20ml Crimp Headspace Clear Vial, 22.5 x 75.5mm, Flat Bottom	100
TC-200 B	20ml Crimp Headspace Clear Vial, 22.5 x 75.5mm, Round Bottom	100
TC-200 C	10ml Crimp Headspace Clear Vial, 22.5 x 46mm, Round Bottom	100
TC-200 D	20ml Crimp Headspace Clear Vial, 22.5 x 75.5mm, Round Bottom, with write on patch	100
TC-200 E	20ml Headspace Clear Vial, 75.5 x 23mm, Rounded Bottom, for Perkin	100
TC-200 F	20ml Precision Thread Vials, 75.2 x 22mm, Rounded Bottom	100
TC-200 G	10ml Crimp Headspace Amber Vial, 22.5 x 46mm, Flat Bottom	100
TC-200 H	10ml Precision Thread Vials, 22.5 x 46mm, Round Bottom	100

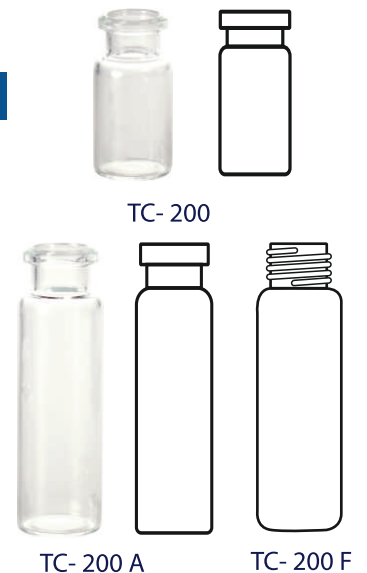

### Colpak® 20mm Caps & Septas

Catalog	Description	Pack
TC-202 L	Silicon White / PTFE Grey, Thickness 3mm, Temperature Resistant 60°C to 200°C	100
TC-206	10mm Center Hole, Crimp Top, Aluminium Cap	100
TC-206 L	10mm Center Hole, Crimp Top, Aluminium Cap with Silicone White / PTFE Gray	100
TC-208 K	18mm Magnetic Precision Thread Screw Cap, 8mm Center Hole, with Silicone White / PTFE Sky Blue, 1.5mm	100



20mm Aluminum Septas & Caps



Headspace Neck (bevelled Neck)



TC- 208 K 18 mm Screw Cap Coming Soon

### Colpak® 20mm Crimper

Catalog	Description	Pack
TC-209 A	Crimper for 20mm Aluminium Caps	1



### Correct Vial Crimping

Achieve accurate results with correctly Crimped vials. A correctly crimped vial is neither over-crimped nor under-crimped. Over-crimping may cause coring or poor septum resealing, while under-crimping can cause evaporation problems.

With proper adjustment of the vial crimpers, Perfect crimping can be achieved every time. When the vial is crimped perfectly, the cap should not be able to rotate and the septum should appear smooth and level.

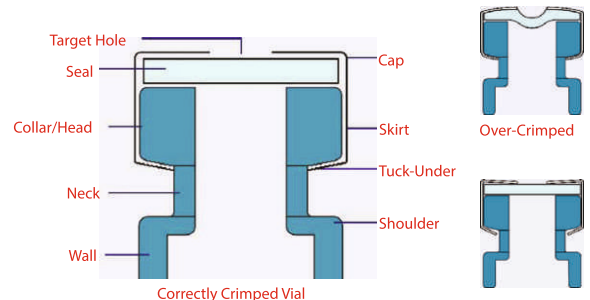

## 1) Haemometer (SAHLI type) & Accessories

The Shandilya brand haemometer housing is moulded from thermo-setting phenol formaldehyde resin which makes it resistant to most laboratory reagents. It is also very convenient to handle, light in weight, and gives unlimited service. The permanent non-fading colour standards are made with optical precision for accurate and exact matching of colour. They are comparable with international master colour standards of haemoglobin values. They never fade or get discoloured.



Catalog	Description	Pack
31-00-001	Prismatic, Square Tube with precision 20cm pipette	Each
31-00-002	Plano parallel, Square Tube with precision 20cm pipette	Each
31-01-002	Plano parallel, Round Tube with precision 20cm pipette	Each



### 2) Accessories: Square Tubes

Made up of hard borosilicate glass with permanent non fading scales on two opposite sides, one in yellow and another in red. Yellow colour scale indicates absolute value of gms/100cc and red one indicates value of haemoglobin percentage in blood. Conforms to IS 9430

Catalog	Description	Pack
31-00-003	Square Tube	12 nos.



### 3) Round Tubes

Made up of hard borosilicate glass with permanent non fading scales on two opposite sides, one in yellow and another in red. Yellow colour scale indicates absolute value of gms/100cc and red one indicates value of haemoglobin percentage in blood. Conforms to IS 9430

Catalog	Description	Pack
31-01-102	Round Tube	12 nos.



### 4) Wintrobe Tubes

Made of hard borosilicate corning glass with uniform bore so as to avoid breakage during centrifugation. Very useful in determining packed cell volume of blood. Conforms to IS 3741

Catalog	Description	Pack
31-01-102	Round Tube	12 nos.

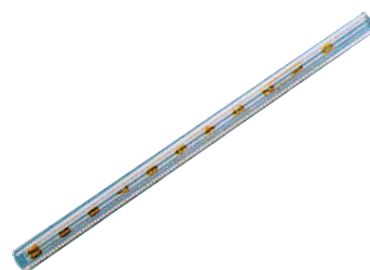



**Sales Office Address :**

Top Syringe Compound, W. E. Highway, Pandurangwadi, Mira Road (East), Thane 401 104. INDIA.

**Tel.: +91-22-2845-7788 • Email : [sales@topsyringe.com](mailto:sales@topsyringe.com)**

**Register Office Address :**

10-11, Prospect Chamber Annexe, 317-21, Dr. D. N. Road, Fort, Mumbai 400 001. INDIA.

**Website : [www.topsyringe.com](http://www.topsyringe.com)**